



STANDARD WIPER KIT

FEATURES

- Motor with adjustable sweep angle of 80° or 110°
- Adjustable left or right self-parking
- Standard adjustment 80° - left self-parking
- Motor shaft and mounting plate in stainless steel
- Arm/blade combination up to 14" x 14"

Wiring Instructions Standard Motor - Black

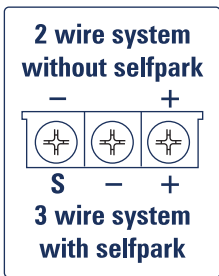

(Customer Supplies Wires)
Connect appropriate wire, following the guide provided on motor.
Note: "S" is "Self Park."

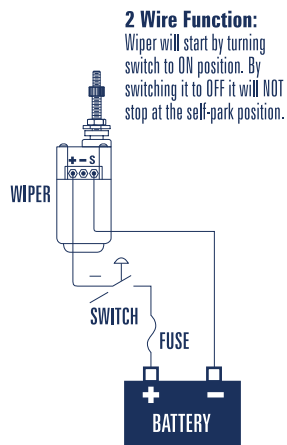
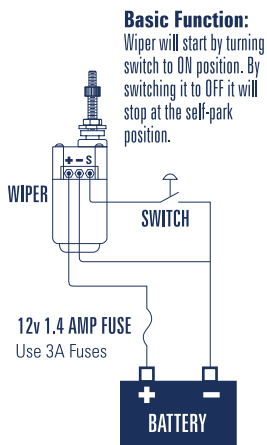

Standard Motor (Customer Supplies Wires)

Safety note: Be sure to use appropriate wire gauge to support the voltage and distance from your power source.

Instructions to Install Wiper Arm

- Use an allen wrench (not included) to loosen set screw if needed.
- Slide arm over shaft and tighten set screw

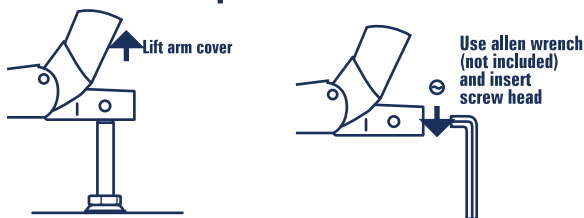

Instruction to adjust left or right self-parking

- Remove the motor base cover
- Locate the small plastic cam and gently lift the cam off the self park shaft.
- Rotate the cam 180° so it is facing the opposite direction. (You may need to gently pull back the metal contact plate.)
- Replace the cam over the self park shaft
- Replace cover

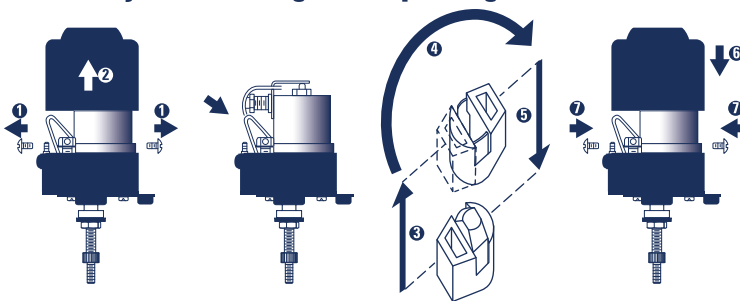

Instruction to change sweep angle 80° or 110°

- Remove cover plate
- Lift sweep mechanism from gear and move to the opening closest to the center of gear (for 110°)
- Reposition shaft arm on underside of cover plate so that it fits into sweep angle cam.
- Reposition gasket and reattach cover plate

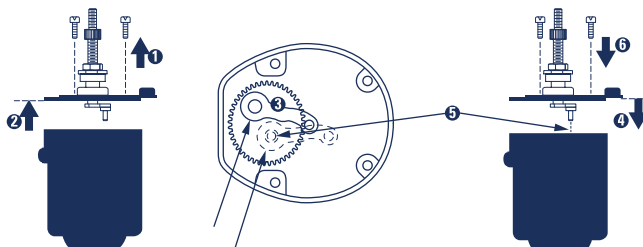



STANDARD WIPER KIT

For Model: 31011

Contains the following:

- (1) Standard Motor
- (1) 11" Wiper Blade
- (1) 11" x 14" Adjustable Arm



Made in Taiwan for Schmitt & Ongaro Products
schmittongaromarine.com



STANDARD WIPER KIT

For Model: 31011

Contains the following:

- (1) Standard Motor
- (1) 11" Wiper Blade
- (1) 11" x 14" Adjustable Arm

FEATURES:

- 12 Volt Motor
- 80° or 110° Sweep Angle
- Self Park - Left or Right
- Insulated Grounding



Made in Taiwan for Schmitt & Ongaro Products
schmittongaromarine.com

schmittongaromarine.com

Schmitt & Ongaro Marine Products offer a 3 year limited warranty on the wiper motors to the original purchaser. This warranty does not apply to any product that has been modified or altered to affect its intended operation. The date of warranty will begin on the date that the product is purchased by the customer. Proof of purchase must be provided for all warranty claims. Customer must contact Schmitt & Ongaro Marine Products at 1-866-724-6488 to obtain return authorization number and instructions for return. Please visit our website for full warranty details.

THREE YEAR WARRANTY

