



Innovative marine electrical products—Built to last



Installation Manual

DC Battery Management, DC Branch, AC Main,
AC Branch, AC Source Selection, and
AC/DC Combination Panels.

Table of Contents

Specifications	1
Cautions and Resource Documents	2
Panel and Cutout Dimensions	3
Installation	4
Wire Size	5
DC Label Backlight and Circuit Status System	6
DC Shunt for Analog Ammeters	8
DC Shunt for Digital Ammeters and Multimeter.....	9
Installation Completion Testing	10
Accessories	11
360 Panel Functions	13
Book List	17

SPECIFICATIONS

Stock Panels:

Specifications for this panel are located on the panel product page at www.blueseas.com. To locate specifications **SEARCH** by part number (four digit number found on the back of the panel), click the

DETAILED SPECIFICATIONS tab.

The **SPECIFICATIONS** table contains: specifications for the panel, and a list of all installed components and their part numbers. To view component specifications, click each component part number and navigate to component specifications.

Custom Panels:

A panel wiring schematic and a list of components are included with the panel.

Material:

Metal frame—0.125" 5052 aluminum black powder coat

Front bezels—UV stabilized Polycarbonate ASA blend

Current Consumption:

Backlighting—2.75 milliamperes per nominal circuit

Current Rating:

Busbars—100 amperes

Note: If hot feed wire is attached in the center of the bus it allows each bus to carry up to 200 Amperes.

Available Panel Voltages:

Panel—12 Volt DC, 12/24 Volt DC, 120 Volt AC, 230 Volt AC, 240 Volt AC

Backlighting and circuit status indication—12 Volt DC, 24 Volt DC by replacing existing LED harness with 12 to 24 Volt Conversion Kit (PN 4113)

Circuit breakers can be replaced by breakers with different ratings.

CAUTIONS

- ✔ If you are not knowledgeable about electrical systems, consult an electrical professional to install this panel.
- ✔ This panel is not waterproof. Do not install panel in a location where it is exposed to water.
- ✔ Some stock panels are not ignition protected. Such panels must NOT be installed in an explosive environment including gasoline engine rooms or battery compartments. Check to see if your panel is ignition protected.
- ✔ If an inverter is installed on the vessel, its power leads must be disconnected at the battery before the panel is installed. Many inverters have a “sleep mode” in which their voltage potential may not be detectable with measuring equipment.
- ✔ If an AC generator is installed on the vessel, it must be stopped and rendered inoperable before the panel is installed.
- ✔ Verify that no other DC and AC sources are connected to the vessel’s wiring before installing the panel.
- ✔ For AC/DC combination panels, ABYC compliance requires that when the panel is open, there can be no access to energized AC parts without the use of tools (ABYC E11.11.1.1). To comply, Insulating Rear Covers should be installed over AC circuitry. USCG compliance requires that DC circuitry not protected by a fuse or circuit breaker must have a boot, or an insulating rear cover (Code of Federal Regulations 183.445)
- ✔ USCG compliance requires that DC circuitry, not protected by a fuse or circuit breaker, must have a boot or an insulating rear cover (Code of Federal Regulations 183.445)

RESOURCE DOCUMENTS

For additional information about installing power distribution panels, refer to resource documents available at www.blueseas.com.

PANEL AND CUTOUT DIMENSIONS

The 360 Panel System consists of modules. Each module contains a meter, a battery switch, 4 or 8 circuit breakers etc. In the table below, panels are identified by the number of rows and columns of the modules they contain. For example, a 2x4 panel consists of 2 rows of 4 modules.

Rows x Columns	Panel Height in" (mm)	Panel Width in" (mm)	Cutout Height in" (mm)	Cutout Width in" (mm)
1×1	4 ¾ (121)	4 ⅞ (124)	3 ⅝ (84)	4 ⅜ (110)
1×2	4 ¾ (121)	9 ¼ (235)	3 ⅝ (84)	8 ¾ (221)
1×3	4 ¾ (121)	13 ⅝ (346)	3 ⅝ (84)	13 ⅛ (332)
1×4	4 ¾ (121)	18 (457)	3 ⅝ (84)	17 ½ (444)
1×5	4 ¾ (121)	22 ⅜ (568)	3 ⅝ (84)	21 ⅞ (555)
2×1	7 ¾ (197)	4 ⅞ (124)	6 ⅝ (160)	4 ⅜ (110)
2×2	7 ¾ (197)	9 ¼ (235)	6 ⅝ (160)	8 ¾ (221)
2×3	7 ¾ (197)	13 ⅝ (346)	6 ⅝ (160)	13 ⅛ (332)
2×4	7 ¾ (197)	18 (457)	6 ⅝ (160)	17 ½ (444)
2×5	7 ¾ (197)	22 ⅜ (568)	6 ⅝ (160)	21 ⅞ (555)
3×1	10 ¾ (273)	4 ⅞ (124)	9 ⅝ (236)	4 ⅜ (110)
3×2	10 ¾ (273)	9 ¼ (235)	9 ⅝ (236)	8 ¾ (221)
3×3	10 ¾ (273)	13 ⅝ (346)	9 ⅝ (236)	13 ⅛ (332)
3×4	10 ¾ (273)	18 (457)	9 ⅝ (236)	17 ½ (444)
3×5	10 ¾ (273)	22 ⅜ (568)	9 ⅝ (236)	21 ⅞ (555)
4×1	13 ¾ (349)	4 ⅞ (124)	12 ⅝ (312)	4 ⅜ (110)
4×2	13 ¾ (349)	9 ¼ (235)	12 ⅝ (312)	8 ¾ (221)
4×3	13 ¾ (349)	13 ⅝ (346)	12 ⅝ (312)	13 ⅛ (332)
4×4	13 ¾ (349)	18 (457)	12 ⅝ (312)	17 ½ (444)
4×5	13 ¾ (349)	22 ⅜ (568)	12 ⅝ (312)	21 ⅞ (555)
5×2	16 ¾ (426)	9 ¼ (235)	15 ⅝ (389)	8 ¾ (221)

INSTALLATION

Panel Wiring Schematic—A panel wiring schematic is available on the panel product page at www.blueseas.com. To locate the schematic, **SEARCH** by part number (four digit number found on the back of the panel), click the **PRODUCT DOCUMENTS** tab, under **INSTALLATION**, click “Wiring Schematic”.

1. **Disconnect all AC and DC power.** To reduce the risk of electrical shock, disconnect all AC and DC power during installation. This includes inverters, generators, shore power attachments, and any other device capable of supplying AC or DC power to the ship’s circuits.
2. **Select mounting location and cut opening.** Select a convenient location to mount the panel. When choosing a location, refer to the Cautions on page 2. Also, choose a location that is protected from spray. Cut an opening for the panel using the enclosed full size cutout template, or use the cutout dimensions provided in the table on page 3.
3. **Verify circuit breaker ratings.** Verify that each branch circuit breaker installed is the correct rating for the circuit. The circuit breaker must have a rating less than the allowable amperage of the wire, yet greater than the circuit’s continuous current. Replace pre-installed circuit breakers if necessary. Blue Sea Systems’ DC Circuit Wizard, <http://dc.circuitwizard.blueseas.com/> will guide you in suitable circuit protection selection.
4. **Mount External Busbars, supplied with all 360 Panels, near the panel:**
 - AC panels—DualBus busbar(s) to connect AC neutral and safety ground.
 - DC panels—Common busbar(s) to connect DC negative.

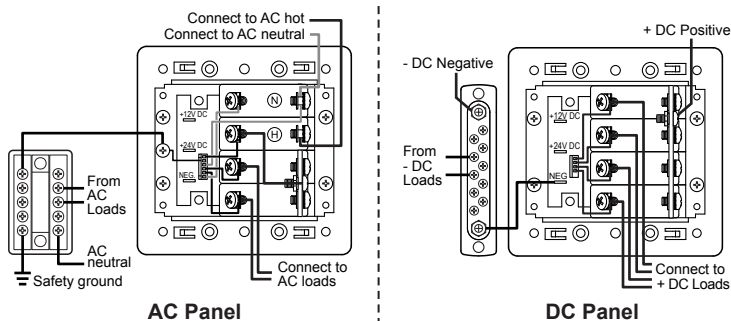

WIRE SIZE

DC Circuits: Use Blue Sea Systems' DC Circuit Wizard online at <http://dc.circuitwizard.blueseasystems.com/> to guide you in suitable wire size selection for each DC Feed, Main, and Branch Circuit.

Voltage drop along a circuit path is cumulative. To achieve suitable voltage drop along a path consisting of multiple segments, use the DC Circuit Wizard to assign voltage drop values to each segment that add up to the desired voltage drop.

Be sure to measure the length of wire from power source to load and return.

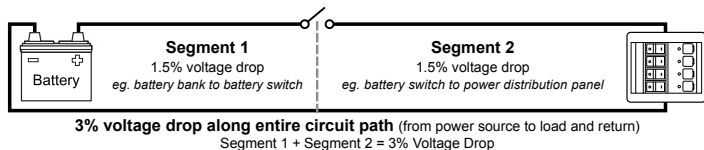

AC Circuits: For each AC Feed and Branch circuit, the ABYC table below lists the minimum wire size.

ABYC E-11 Table IV 105°C (122°F) Wire

Wire Size (AWG)	Allowable Amperage of Conductors	
	Outside Engine Spaces	Inside Engine Spaces
16	25.0	21.3
14	35.0	29.8
12	45.0	38.3
10	60.0	51.0
8	80.0	68.0
6	120.0	102.0
4	160.0	136.0
2	210.0	178.5

This ABYC table is for wire with 105°C (122°F) insulation rating and no more than 2 conductors bundled together. It is not suitable for sizing flexible shore power cords. The values will allow conductors to reach their full 105°C (122°F) rated temperature.

Many experts in the marine electrical industry recommend using wires that are one or two sizes larger than shown in the table above to reduce the operating temperature of the wire.

For more information go to www.blueseasystems.com

DC LABEL BACKLIGHT AND CIRCUIT STATUS SYSTEM

CIRCUIT BREAKER MODULES

The label backlighting and circuit status indicator is pre-wired for 12 Volts DC:

1. Connect +12 Volts to the +12V DC quick-connect terminal (piggy back lug on panels with jumper wires) on the LED circuit board.
2. Connect the negative of the battery system to the NEG quick-connect terminal (piggy back lug on panels with jumper wires) on the LED circuit board.

To convert the label backlighting and circuit status indication to 24 Volts DC:

1. Replace the 12 Volt DC LED harness with a 12 to 24 Volt DC Conversion Kit (PN 4113, not included with the panel).
Note: 360 panels with more than one module have backlight jumper wires connecting modules. These jumper wires must be moved when connecting to 24 Volts DC.
2. Move jumper wires from the +12V DC quick-connect terminal to the +24V DC quick-connect terminal on the LED circuit board.
3. Connect +24 Volts to the +24V DC quick-connect terminal (piggy back lug on panels with jumper wires) on the LED circuit board.
4. Connect the negative of the battery system to the NEG quick-connect terminal (piggy back lug on panels with jumper wires) on the LED circuit board.

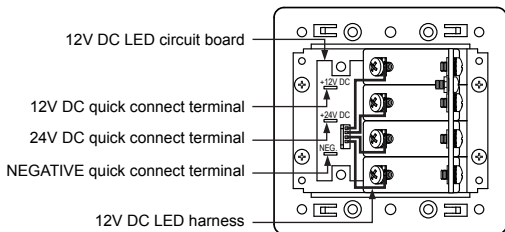

DC LABEL BACKLIGHT SYSTEM

ROTARY SWITCH MODULES

12 Volts DC:

1. Connect +12 Volts DC to the two Red wires coming from the backlight plug connector.
2. Connect the negative of the battery system to the two Yellow wires coming from the backlight plug connector.

24 Volts DC:

1. Splice together the Red and Yellow wires coming from the center positions of the backlight plug connector using a suitable lug connector.
2. Connect +24 Volts DC to the Red wire coming from the outside position of the backlight plug connector.
3. Connect the negative of the battery system to the Yellow wire coming from the outside position of the backlight plug connector.

Label Backlight System

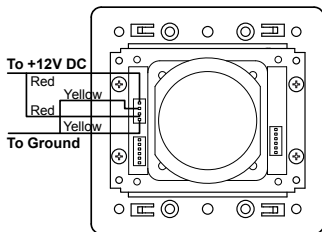

12 Volt DC

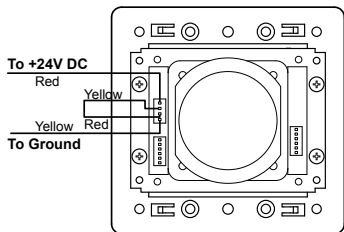

24 Volt DC

DC SHUNT FOR ANALOG AMMETERS

Install shunt for analog DC current measurement:

An external shunt is supplied with 360 panels that include a DC analog ammeter. Install the shunt at any point in the DC positive or negative, preferably in the most direct high current path (do not reroute the direct current path to accommodate shunt placement). Mount shunt close to the panel to keep the sense wires that run from the shunt to the meter short. Short sense wires minimize voltage loss and result in the most accurate metering. Mounting the shunt close to the battery bank may make it easier to include more circuits, such as 24-hour circuits, in the metering. Wire runs up to 50 feet using #16 AWG wire may produce errors up to 1%. Use 16 AWG wire for sense connections up to 50 feet in length; use higher gauge wire for longer wire runs. There should be a 1 Ampere fuse in both sense wires near the shunt terminals.

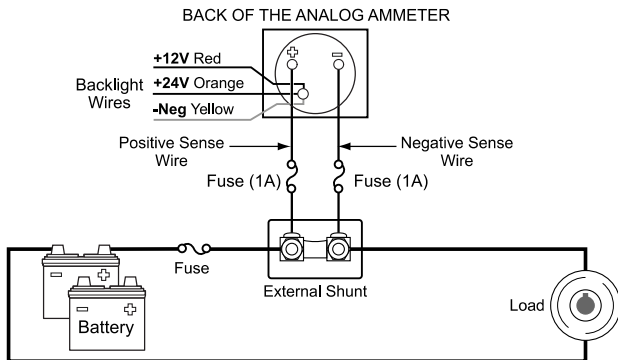

Notes:

1. Where a long run is required between meter and shunt, minimize interference by twisting the sense wires together.
2. If the shunt is installed in the negative feed line, no fuses are required.

DC SHUNT FOR DIGITAL AMMETERS AND MULTIMETER

Install shunt for digital DC current measurement:

Caution: The shunt must be installed in the negative line to avoid damage to the meter. Positive voltage applied to digital meter terminals #4 and #5 will cause damage to the meter.

An external shunt is supplied with 360 panels that include a DC Digital Ammeter or Multimeter. Install the shunt at any point in the DC negative feed line to the panel. Mount it close to the panel to keep the sense wires that run from the shunt to the meter short. Short sense wires minimize voltage loss and interference, and result in the most accurate metering. Mounting it close to the battery bank may make it easier to include more circuits, such as 24-hour circuits, in the metering. Wire runs greater than 50 feet using #16 AWG wire may produce errors up to 1%. Use 16 AWG wire for sense connections.

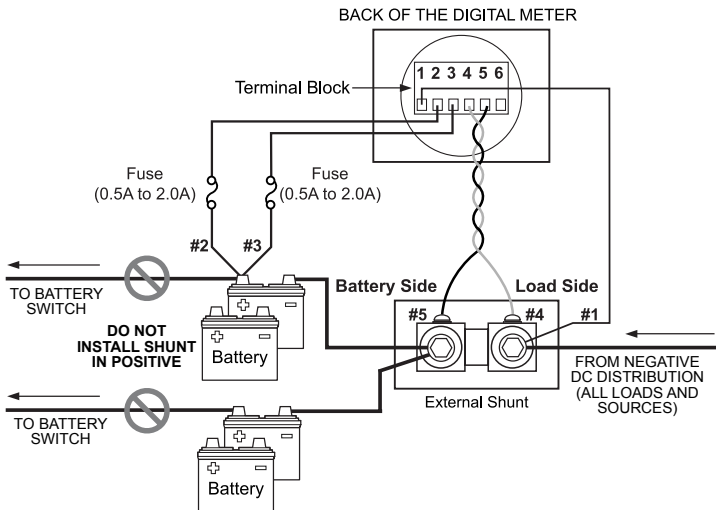

INSTALLATION COMPLETION TESTING

1. Apply labels for main and branch circuits—additional labels are available at www.blueseas.com.
2. Fasten panel to the mounting surface.

Test the Panel:

1. Use a multimeter to verify continuity before power is applied. This procedure takes a little time, but is recommended, especially if some elements of a previous installation might not have been properly labeled, or followed the expected color codes.
2. Reconnect all AC and DC power.
3. Turn the main switch ON.
4. If there are meters, check DC voltage and current measurements with the DC meter; check AC voltage, current, power, and frequency with AC meter.
5. Turn on each branch circuit to verify power to each circuit.

Shore Power Cable Connection:

1. Connect the vessel's shore 1, shore 2, and genset power and verify that a Reverse Polarity light is not illuminated.
2. If the red Reverse Polarity light is on, then either the hot and ground or the hot and neutral wires have been crossed. If there is an error, starting at the panel, trace the connection back as far as necessary to locate the error.

Source Selection Rotary Switch:

It is very important that the wiring be connected according to the panel wiring schematic. The panel wiring schematic is on the panel product page at www.blueseas.com. The line and neutral from each source must be paired together and not connected such that the switch selects line from one source and neutral from another. Verify the connections and see that each connection is securely tightened, including terminals on the switch where no wires are attached.

Selector switches may fail if there is dust between the contacts. Blow out the switch using a high-pressure air source.

ACCESSORIES

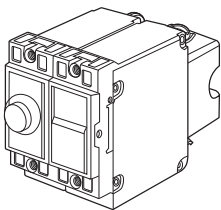

Residual Current Circuit Breaker (RCBO)

- Provides both ground fault leakage protection and circuit protection in a panel mounted breaker.
- 5mA leakage protection for Branch circuits (meets GFCI requirements)
- 30mA leakage protection for Main circuits.

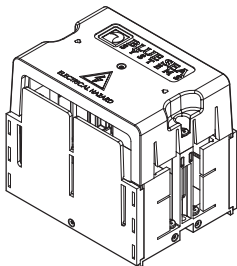

Insulating Rear Covers

- Provides electrical insulation for exposed panel backs.

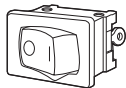

Rocker Switches

- Provides switching options for applications requiring different pole and throw configurations.

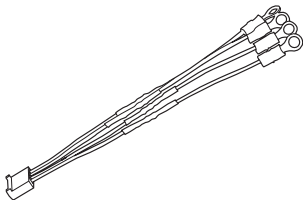

12 to 24 Volt DC Conversion Kit

- Designed to convert LED circuit status indication from standard 12 Volt DC systems to 24 Volt DC systems on toggle and rocker style circuit breakers.

ACCESSORIES

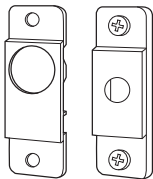

Adapters

- Adapts Toggle A-Series Circuit Breakers, Push Button Reset-Only Circuit Breakers, and Panel Switches to the circuit breaker aperture of the 360 Distribution Panels.

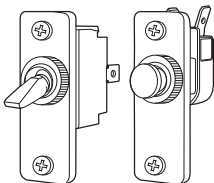

Panel Switches

- Toggle—Provides switching action other than ON-OFF or different pole configuration separate from circuit protection.
- Push Button—Provides momentary switching action separate from circuit protection.

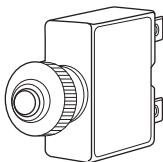

Push Button Reset-Only Circuit Breakers

- Branch circuit breakers—can be used for 24-hour circuit protection.



360 Panel Plugs

- Used to plug blank circuit breaker aperture.

360 PANEL FUNCTIONS

360 Panels are built with modules providing the following functions:

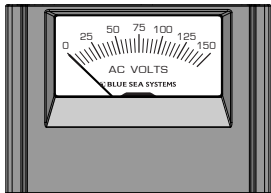

AC and DC 60° Analog Meters

- Monitor volts or amperes.
- Backlit meter face.

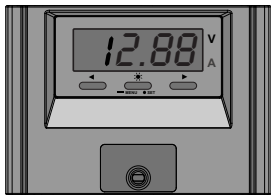

AC and DC Digital Meters

- Monitor volts, amperes, watts, frequency.
- DC voltage alarms, AC voltage and amperage alarms.

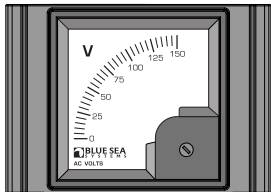

AC and DC 90° Analog DIN Meters

- Monitor volts or amperes.
- Backlit meter face.

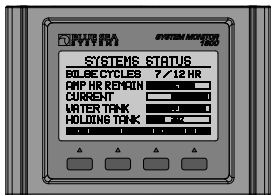

Systems Monitor 1800

- Monitors volts, amperes, watts, frequency, DC ampere-hours.
- Monitor tanks and bilge condition.
- Alarms for all measured values.

360 PANEL FUNCTIONS

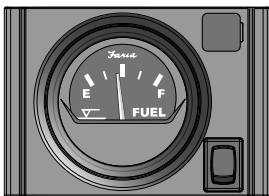

2" Round Gauge

- Monitors engine, tanks, electrical, clock or hour meter values.

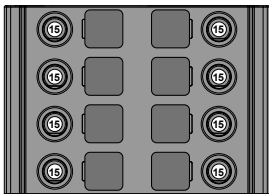

DC Push Button Reset-Only Circuit Breakers

- Circuit protection only for un-switched 24-hour circuits or switches at other locations.

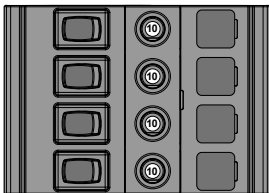

DC Push Button Reset-Only Circuit Breakers with Rocker Switches

- Economical switched circuit protection for low amp circuits.

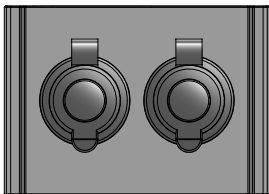

DC 12 Volt Sockets

- Twin 12 Volt receptacles integrated into the 360 Distribution Panel.

360 PANEL FUNCTIONS

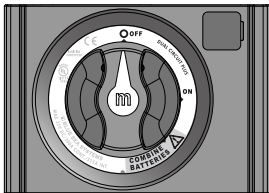

m-Series Battery Switches

- ON/OFF, Selector, Dual Circuit™, and Dual Circuit Plus™ enable sophisticated battery management systems to be integrated into the 360 Distribution Panel.



Rocker Style Circuit Breakers

- Modern styling, resistance to accidental switching and restricted switching models.
- Available in single, double, or triple pole from 5-300 Amps.

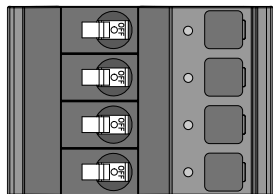

Toggle Style Circuit Breakers

- For a traditional look and feel.
- Available with black or white toggle breakers from 5-50 Amps.

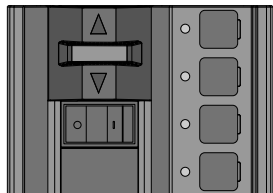

AC Multiple Source Slide Management

- Safe management of multiple AC sources.
- Available in rocker or toggle styles.

360 PANEL FUNCTIONS

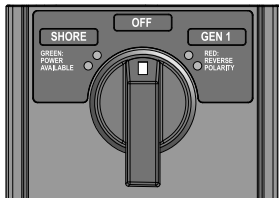

AC Multiple Source Rotary Switch Management

- Safe management of multiple AC sources with a fully backlit Rotary Switch AC management system.

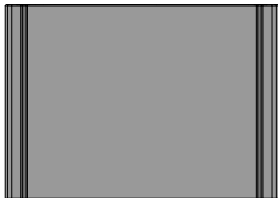

Blank Panel

- Platform for a variety of controls and instruments that can be mounted into the 360 Distribution Panel for an integrated appearance.

BOOK LIST

- Calder, Nigel. *Boatowner's Mechanical and Electrical Manual*, third edition
- Casey, Don. *Sailboat Electrical Systems: Improvement, Wiring and Repair*
- Casey, Don. *Sailboat Electrics Simplified*
- Payne, John C. *The Fisherman's Electrical Manual*
- Payne, John C. *Understanding Boat Batteries and Battery Charging*
- Payne, John C. *Understanding Boat Wiring*
- Payne, John C. *The Marine Electrical and Electronics Bible*
- Payne, John C. *The Motorboat Electrical and Electronics Manual*
- Sherman, Ed. *Powerboater's Guide to Electrical Systems: Maintenance, Troubleshooting and Improvements*
- Sherman, Ed. *Advanced Marine Electrics and Electronics Troubleshooting*
- Wing, Charlie. *Boatowner's Illustrated – Electrical Handbook*, second edition

Contact

Phone: 360-738-8230
Customer Service: Toll Free 1-800-222-7617
Fax: 360-734-4195
E-mail Address: conductor@blueseas.com
Internet Address: www.blueseas.com
Head Office Address: 425 Sequoia Drive
Bellingham, Washington 98226 USA

Guarantee

Any Blue Sea Systems product with which a customer is not satisfied may be returned for a refund or replacement at any time.