

SRT/PHT SERIES

PANEL MOUNT SUNLIGHT READABLE & PILOT HOUSE DISPLAYS



Contents

1	Revision history	4
2	About this manual	4
3	Disclaimer	4
4	Box contents and available options	5
5	Description	7
6	Product identification.....	7
7	Safety precautions.....	8
8	Installation.....	9
8.1	Mounting the monitor.....	9
8.1.1	Panel mount.....	9
8.1.2	VESA mount	10
8.1.3	Rearmount	10
8.2	Connecting I/O	11
8.2.1	Standard I/O, without dimming option.....	11
8.2.2	Extended I/O, NCOM and (external) dimming.....	12
8.3	Front controls	13
8.4	Setup for Operation (OSD-menu).....	14
8.4.1	OSD status LED	15
8.4.2	OSD menu “Option”	15
8.4.3	OSD menu “Picture”	16
8.4.4	OSD menu “Function”	17
8.4.5	OSD menu “Setup”	18
8.5	Engineering OSD with dimming encoder.....	19
8.6	Projected capacitive touch screen	20
8.7	Resistive touch screen	20
9	Trouble shooting	21
9.1	Power	21
9.2	Image.....	21
9.3	Dimming control.....	22
9.4	Touch screen	22
10	Specifications	23
10.1	Video	23
10.1.1	Compatibility and video standards	23
10.1.2	Applicable Graphic Mode	24
10.2	Dimensions K, KE, KG and KGE models.....	25
10.3	Dimensions D and DE models.....	26
10.4	Dimensions R models	27
10.5	Electrical and environmental.....	28
10.6	Model related specifications	29
10.7	Pin assignments.....	30

- 11 Pixel policy (ISO 13406-2 Scan Guidelines) 32
- 12 Sticking image 33
- 13 Maintenance 34
- 14 Warranty 35
 - 14.1 Coverage of the Warranty 35
 - 14.2 Warranty Exclusions and Disclaimer 35
 - 14.3 Obtaining Warranty Service 36

1 Revision history

Before installation or using the monitor make sure you have the latest version of this owners manual.

Version	Remark
V3.0	Complete revision to new NCOM-AD
V3.01	External dimming added 8.2.2
V3.02	IEC certificate
V3.03	Dimension N270KGE

2 About this manual

The SRT/PHT SERIES consists of several models. Since all models are built using the same concept (similar components), all data has been collected to create one manual that describes the entire series. As an option, the SRT/PHT SERIES glass version available with IEC60945 certificate. Details are shown as follows:



Take special attention when using option IEC60945/type approval certification on your monitor

This document contains technical and users information about your monitor. Please make sure you are using the latest version of this manual when installing a new product. Although we strive to be as complete as possible, there will always be additions made. All updates of this document are subject to change without notice. The revision history is shown in chapter 1.







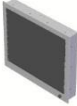

3 Disclaimer

Seatronx makes no representations or warranties, either expressed or implied, with respect to the contents hereof and specifically disclaims any warranties, merchantability or fitness for any particular purpose. Further, Seatronx reserves the right to revise this publication and to make changes from time to time in the contents hereof without obligation of Seatronx to notify any person of such revision or changes. Please follow these safety instructions for best performance, and long life for your monitor

Copyright © 2018 by Seatronx. All rights reserved. No part of this publication may be reproduced, transmitted, transcribed, stored in a retrieval system or translated into any language or computer language, in any form or by any means, electronic, mechanical, magnetic, optical, chemical, manual or otherwise, without the prior written permission of Seatronx.

4 Box contents and available options

Please check the box contents right after receiving the equipment. The contents depend on the options ordered.

Image	Description	Remark
	Monitor	
	VGA cable (15p HD-Sub)	M/M
	DVI-D Cable	M/M
	HDMI Cable	M/M
Optional 110/230VAC input:		
	External power adapter (230VAC<>12VDC)	N.a. with 9~36VDC input option
	Mains cord	Euro Style
Optional touch:		
	USB cable	Optional touch A/B
	RS-232 cable	Optional

Optional Kiosk mounting:

Mounting brackets with M5x50 screws
and M5 nuts

Panel mount model only

Optional Rear mounting:

Mounting brackets with M4 screw

Rear mount model only

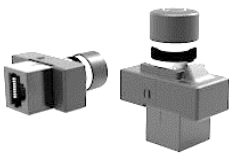
External dimming/central dimming:

External encoder or potentiometer with
LIN-Bus and LED-backlight

Can be mounted on a 1mm or 4mm
frontplate.

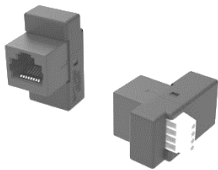

External converter LIN-Bus to 3-button
dimming and OSD control

For momentary switches +, - and power



CAT5 patch cable

For connecting of external LIN-bus
controller to the monitor and daisy
chain monitors for remote control /
central dimming

Programming & PC-control:

Converter cable USB to RS485

For programming and communication
with other computer equipment

5 Description

SRT/PHT SERIES monitors are designed for industrial and marine environments. Special attention has been taken in account regarding robustness, easy installation and stylish appearance. This product is meant to be used indoor only, unless otherwise specified. With the right installation, proper operation and sufficient maintenance you will enjoy the monitor for years to come. Please read this manual carefully before installation and usage.

All sizes from the SRT/PHT SERIES can be configured in several models (see table below) such as panel mount, desktop and rearmount all with metal bezel or full glass front. Each model can be supplied with options for brightness, mounting, touch and others. This manual includes all models and options within the SRT/PHT SERIES. If you have any questions please contact us.

Model (xxx = display diagonal)	Description
NxxxK	Panel mount, metal bezel
NxxxKE	Panel mount, metal bezel, extended bezel at bottom side for controls or dim-knob
NxxxKG *1	Panel mount, full glass front
NxxxKGE *1	Panel mount, full glass front, extended bezel at bottom side for controls or dim-knob
NxxxD	VESA mount, metal bezel
NxxxDE	VESA mount, metal bezel, extended bezel at bottom side for controls or dim-knob
NxxxDG	VESA mount, full glass front
NxxxDGE	VESA mount, full glass front, extended bezel at bottom side for controls or dim-knob
NxxxR	Rear mount, no front, optional touch or glass



*1 This model is available with IEC60945 certification:

NxxxKG and NxxxKGE: 104, 106, 121, 121W, 150, 156, 170, 185, 190, 215, 230, 240, 241, 260, 270

The SRT/PHT SERIES is configured from a basic (universal) display chassis. The I/O section and controls (like OSD and dim knob) are identical for each model.

6 Product identification

On the sticker at the backside of the monitor you will find information for product identification.

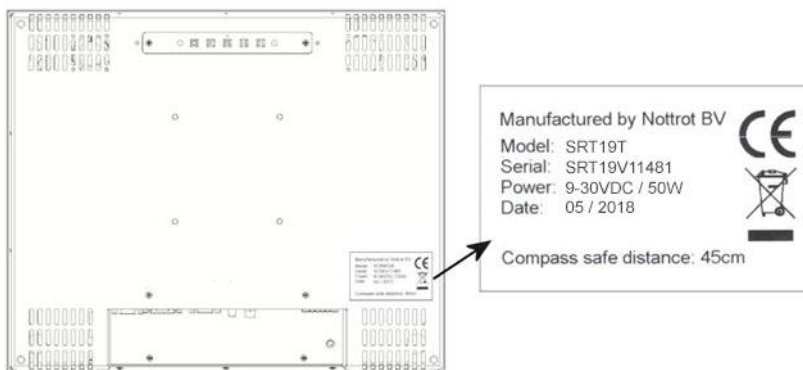

The 'Compass safe distance' is only mentioned on models with IEC60945. The mentioned distance in this picture is just an example.

7 Safety precautions

- Remove power if the monitor is not used for a longer period. This will also result in a longer lifetime of the backlight lamps.
- The cover glass or touch sensor is made of regular (or hardened) glass. This can be scratched or even broken in pieces by hitting it
- Remove power before servicing the monitor
- In case of trouble contact your supplier. Service should only be done by qualified personal
- Never open the chassis. There are no user-serviceable parts inside.
- Never place the display or power supply near warm objects like heaters.
- Never place the display of power supply in direct sunlight.
- Make sure there is enough space for airflow at the backside of the display. Keep the ventilation gaps free from obstacles which can obstruct airflow.
- Keep the display and power supply dry to avoid short circuit. Make sure no fluids can enter the units through the ventilation gaps.
- Wait for at least 6 seconds after switching power off before removing the cables.
- Make sure the temperatures do not exceed max values when storing or using the display.
- When an image is displayed over a long period (this can be from 1 week up to 1 month), the image can stick' to the surface of the TFT front. This can be avoided using screen saver or change colors now and then. Another option is to turn off the display for a few days.
- Never expose the unit to strong vibrations during transport and use.
- The front of the panel is protected by anti glare glass. This glass has a metal coating which can easily be scratched. Never point at this surface with a sharp object.

8 Installation

The SRT/PHT SERIES consists of 3 models: Panel mount, Vesa Mount and Rear Mount. The first part of this chapter describes the universal installation of all models. Please refer to the corresponding paragraphs below for more detailed mounting description per model.

Before installation check the power source to be compatible with the power input of your monitor.

8.1 Mounting the monitor

When installing the monitor first make sure to determine the right place. There should be sufficient airflow at the back of the monitor when using the panel mount version. For any model always make sure that there is no direct sunlight on the monitor. This might heat-up the unit too much.



Determine location in compliance with the minimum radar distance mentioned on the back side of the monitor

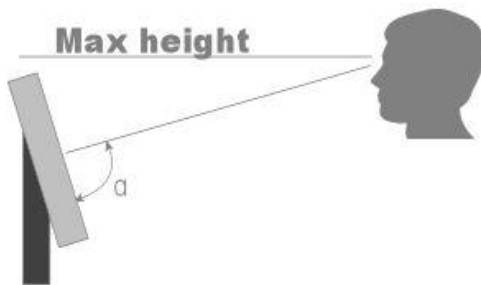

Viewing angle is an theoretical value measured with standard colors and contrast. In real life the monitor should be installed with angle: $120 < \alpha < 90$. This means that viewing from bottom side should be avoided. For viewing convenience install the monitor below eye-level (max height).

8.1.1 Panel mount

The monitor is supplied with mounting brackets for all mounting positions. All brackets need to be installed as shown in figure below to ensure safe and rigid mounting.

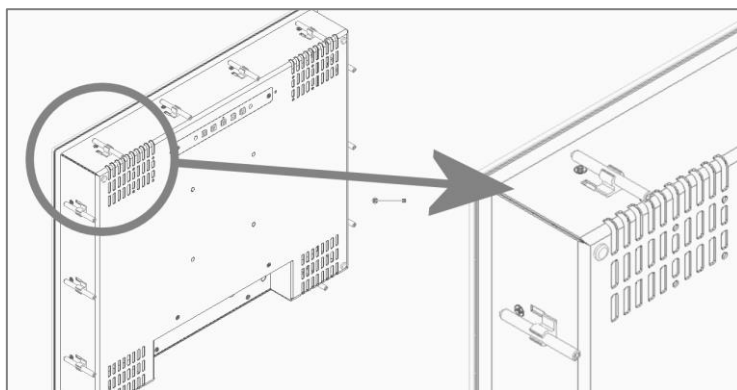

Please follow these steps for successful installation of the panel mount monitor

- Locate the right position for the monitor and take following in account:
 - Leave space around the monitor to ensure sufficient airflow for cooling to meet the temperature specifications mentioned in this manual
 - Mount the monitor in an angled position ($\geq 35^\circ$ from horizontal) to ensure airflow through the monitor
 - Make sure that there is enough airflow (cooling) in the desk. Install a cooling device (fan) if necessary.
- Make a cutout in the desk using the corresponding dimensional drawing

- Gently slide the monitor in the cutout. Do not mechanically force any part of the monitor during installation.
- Install all mounting brackets at the back side using a 2,5mm hex key. To avoid damaging the housing, do not force the screws.



To avoid the M5 screws to come loose, use M5 nuts to lock the screw to the bracket.
The VESA-mount option is not part of certification, since it has not been tested for vibration.

8.1.2 VESA mount

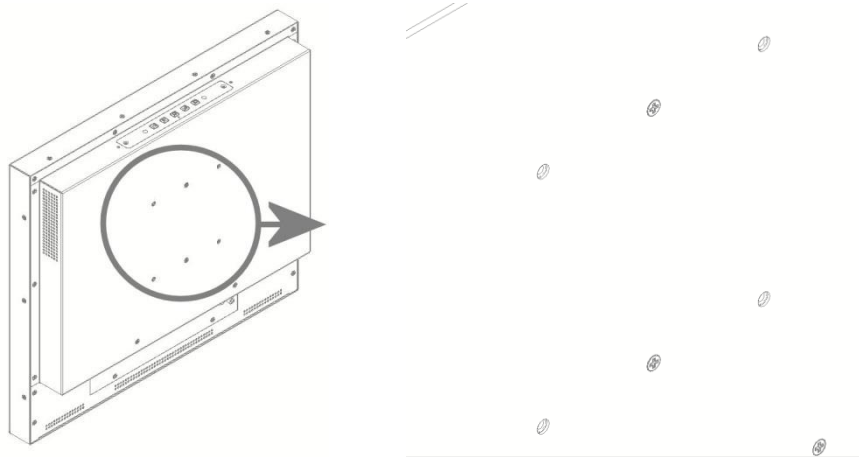

The desktop models can be mounted on any mounting bracket or pedestal corresponding with the right VESA mounting interface standard. Please refer to the dimensional drawings in this manual. Use M4 screws, max insert in the monitor is 8mm.

8.1.3 Rearmount

The rearmount monitor is supplied with sufficient brackets (incl screws) for mounting. The application dependent screws for mount to the desk or frame are not included. The maximum diameter of the screw is 4mm. Please refer to the dimensional drawings for details.

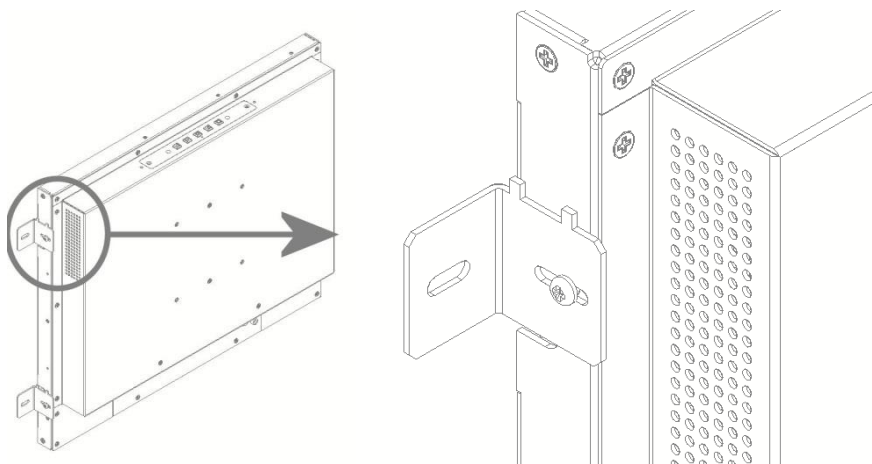

8.2 Connecting I/O

Before connecting any I/O and power, make sure a correct GND connection has been made:



Connect the unit to ground using the M4 screw in the I/O section marked with the grounding symbol:



Make sure all connections are firmly fixed to the unit before powering up. For details regarding pin layouts, please refer to the chapter 10.7 Pin assignments.

Three version are available with different I/O layout. Refer to the section below that matches your situation:

1. Standard I/O, dimming option
2. NCOM-AD with dimming

8.2.1 Standard I/O, without dimming option

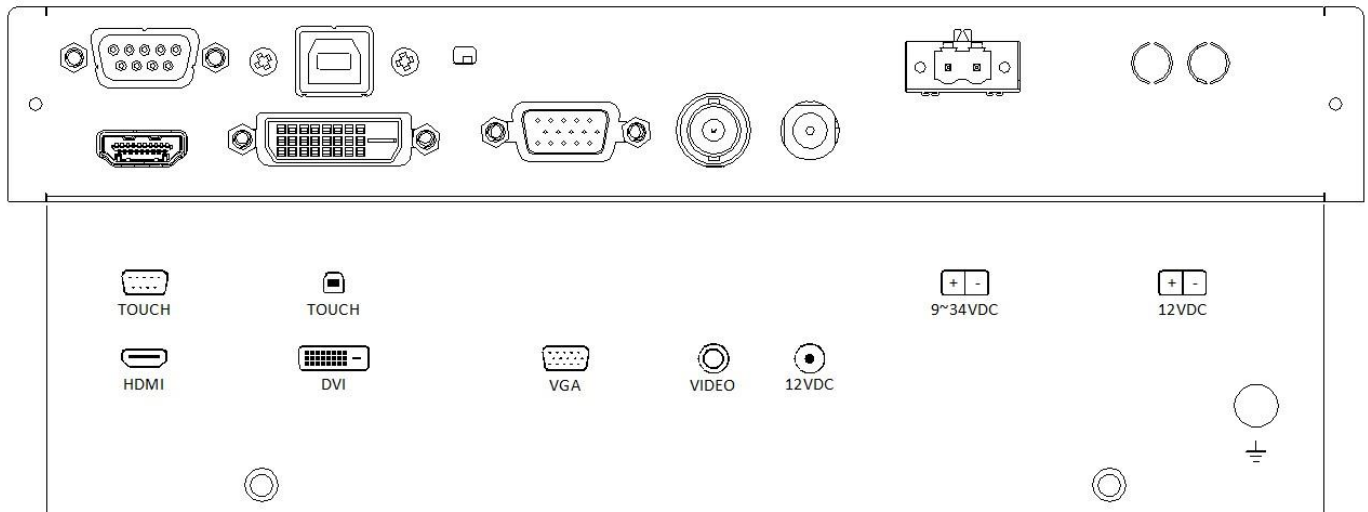

Notes:

- 1- Only one power input can be selected when ordering the monitor. 12VDC is standard, 9~34VDC is optional.
- 2- The most right 12VDC Power input is reserved for screw terminals. Only available on special request



9~36VDC input – tested at nominal input voltage: 24VDC

8.2.2 Extended I/O, NCOM and (external) dimming

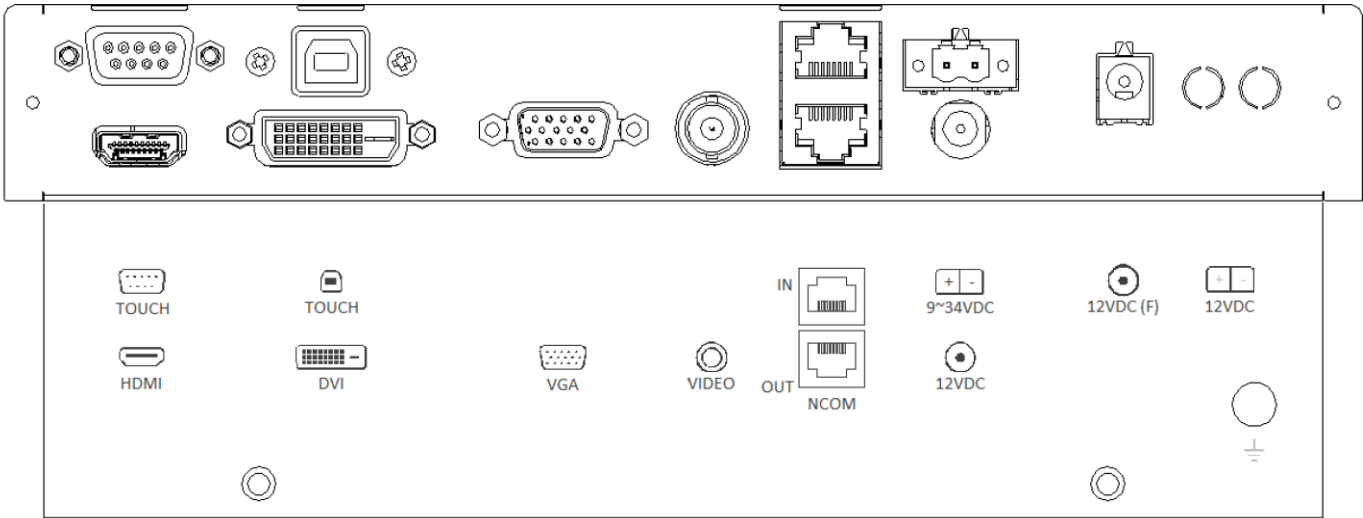

Notes:

- 1- Only one power input can be selected when ordering the monitor. 12VDC is standard, 9~34VDC is optional.
- 2- The most right Power inputs 12VDC and 12VDC(F) are reserved power inputs. These are only available on special request



9~36VDC input – The monitor is tested at nominal input voltage of 24VDC

External dimming devices with LIN protocol can be connected to NCOM-IN. Dimming devices available: encoder, potentiometer, +- buttons, 0-10VDC.

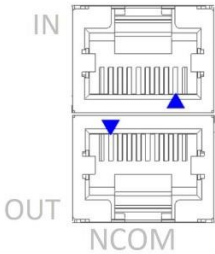

NCOM IN: External dimming knob
 Daisy chain input from previous unit (*
 RS485 control input (*



NCOM OUT: Daisy chain output to next unit (*
 RS485 output to next monitor (*

*) Please refer to the NCOM manual for details.

NCOM_IN can also be connected to a PLC or PC using a RS485 protocol. Please contact us for details.

8.3 Front controls

Depending on the model you have chosen, the following controls can be found at the front side of the unit:

OSD MENU Description	OSD MENU Description
<p>Dim knob</p> 	<p>Dimming knob</p> <ol style="list-style-type: none"> Potentiometer for backlight brightness: rotate CW to increase and CCW to decrease Multifunction knob (Please refer to chapter 8.5): <ul style="list-style-type: none"> Press > 6s to enter OSD menu rotate CW to increase and CCW to decrease Push for standby-modus (power ON/OFF)
<p>Capacitive switch for 'Source select'</p> 	<p>Touching the glass at the symbol will select the next video-input. In the OSD menu you can switch unused sources to OFF to avoid scrolling through unused sources. The status-LED next to the source select symbol shows:</p> <ul style="list-style-type: none"> Green: source is available Red: no valid source at selected input <p>The status-LED is dimmed simultaneously with the backlight.</p>





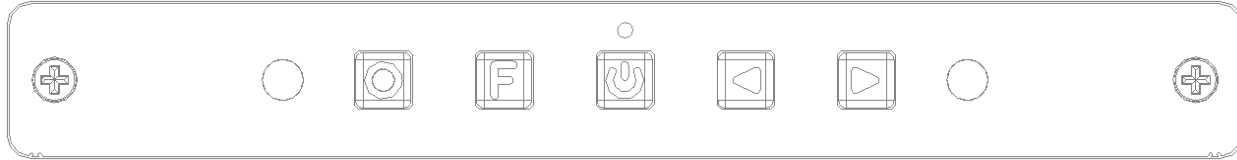

8.4 Setup for Operation (OSD-menu)

The OSD (On Screen Display) provides certain functions to have clear image and others.

This monitor supports 5 buttons OSD Menu operation as a standard.

The status-LED gives information about the signal status: Green



OSD item	Function	Hotkey function
	Menu Enter, Exit	
	Function select, Enter	Source select
	Sleep mode (ON/OFF)	
	Left, Decrease	- Volume - Auto adjust press&hold key for 1 sec for VGA input. This function sets the image parameters (Phase and clock)
	Right, Increase	Backlight adjustment. Use < and > to adjust
	Status LED: Red: No signal Green: Correct input signal on selected source	

The control functions defined on OSD operation are as below.

OSD MENU Description	OSD MENU Description
Picture Mode	Picture preset mode. (Standard, Dynamic, User, Mild)
Contrast	Adjust the contrast of the screen.
Brightness	Adjust the brightness of the screen.
Colour	Adjust the colour of the screen's image.
Sharpness	Adjust the sharpness of the screen's image.
Tint	Adjust the tint of the screen's image.
Color Temp	Adjust the color temperature of the screen's image.
Backlight	Adjust the backlight of the screen. (not available with option wide dimming)
H-Pos	Adjust the horizontal position of the screen's image
V-Pos	Adjust the vertical position of the screen's image
Clock	Adjust the horizontal size of the screen's image
Phase	Adjust the focus of the screen's image
Auto	Automatically adjust the Horizontal position, Vertical position, Window's background or characters should be displayed on your full screen prior to precede this function.
3D NR	Select NR mode. (Off, Strong, Standard, Weak)
Menu Language	Select the OSD language. (English / Русский / Italiano / Nederlands / Deutsch / Español / Française)
Transparency	Adjust the OSD transparency level. (0 ~ 5)
OSD Time Out	Define OSD time out. (Off, 5Sec, 10Sec, 15Sec)
Restore Default	Initializing that memory by factory presetting except OSD language.

Power Save	Adjust the Power Save time. (0 ~ 120Min)
Zoom Mode	Select the zoom mode. (Normal, OverScan, Zoom)
Image Flip	Image is reversed by vertical. (On, Off)
Image Mirror	Image is reversed by horizontal. (On, Off)
Auto Source	Detect the valid input source automatically. (On, Off)
Source	Select video input source using OSD or direct key in Remocon.

8.4.1 OSD status LED

Stage	Led status	Source searching	Backlight
A. Initialization	RED ON	N/A	ON
B1. Sleep	AMBER ON	Waiting valid signal from last input	OFF
B2. Sleep with AutoSource	AMBER ON	Searching for any valid input	OFF
C1. Awake but No Signal	AMBER BLINK	Waiting valid signal from last input	ON
C2. Awake during Auto Source	AMBER ON	Searching for any valid input	ON
C3. Awake with stable video	GREEN ON	Not required	ON
D. Power Off	RED ON	No video input searching in progress	OFF
E. USB Updating	Red/Green Toggle	Not available	N/A

8.4.2 OSD menu “Option”

Symbol	Main menu	Sub Menu
	Menu Language	English / Русский / Italiano / Nederlands / Deutsch / Español / Française
	Transparency	0 ~ 5
	OSD Time Out	Off, 5, 10, 15 (Sec)
	OSD Info	ON/OFF
	Source Setting	CVBS / HDMI / DVI / RGB : “ ON ” or “ OFF ” respectively
	Mute	ON/OFF
	Volume	0 ~ 100
	Restore Default	YES / NO

Notes:

- Enabled sources from Source Setting can be searched via “Auto Source” mode. Source Setting does NOT affect Manual Source Selection.
- “OSD Info” suppresses all OSD output when an application requires silent operation.

8.4.3 OSD menu "Picture"

Symbol	Main menu	Sub Menu
	Signal source RGB (VGA)/DVI:	
	Picture Mode	Standard / Dynamic / User / Mild
	Contrast	0 ~ 100
	Brightness	0 ~ 100
	Colour	0 ~ 100
	Sharpness	0 ~ 100
	Colour Temp	Color Mode: Warm / Medium / Cool / User (R/G/B): 0 ~255
	Backlight (not effective when using a dimming knob or buttons. Do not set to zero, because the screen will be 100% black)	0 ~ 100
	Auto Color (not available in DVI-mode)	There must be a clear black and white image as background, like a MS-Word or Excel file.
	Signal source CVBS/HDMI:	
	Picture Mode	Standard / Dynamic / User / Mild
	Contrast	0 ~ 100
	Brightness	0 ~ 100
	Backlight	0 ~ 100
	Sharpness	0 ~ 100
	Tint	0 ~ 100
	Color	0 ~ 100
	Color Mode	Color Mode: Warm / Medium / Cool / User (R/G/B): 0 ~255
	Backlight (not effective when using a dimming knob or buttons. Do not set to zero, because the screen will be 100% black)	0 ~ 100

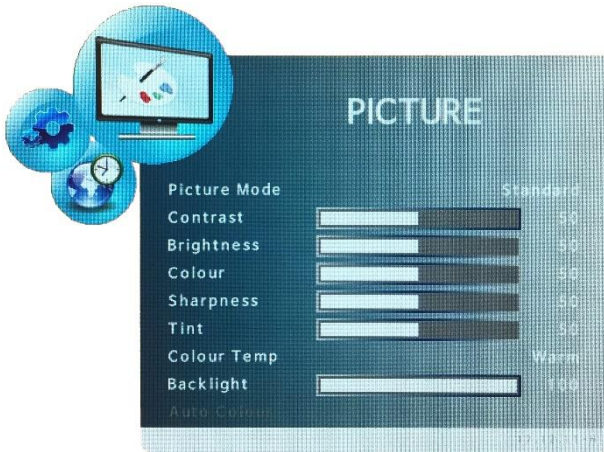

8.4.4 OSD menu “Function”

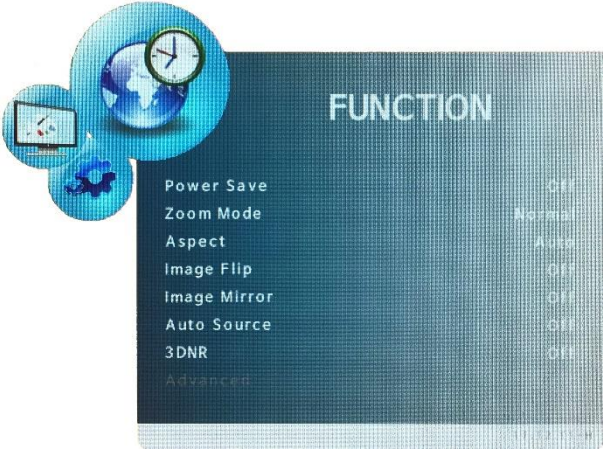
Symbol	Main menu	Sub Menu
	Power Save	Off ~ 120 min.(off, 0.5, 1, 2, 5, 10, 30, 60, 120)
	Zoom Mode	Normal / OverScan / Zoom (for CVBS & HDMI)
	Aspect	Auto / 16 : 9 / 4 : 3 / Fill
	Image Flip	ON / OFF
	Image Mirror	ON / OFF
	Auto Source	ON / OFF (check enable sources)
	XGA Mode	1024x768 / 1280x768 / 1360x768 / 1366x768
	3DNR	Off / Strong / Standard / Weak
	Advanced	H-pos 0 ~ 100 V-pos 0 ~ 100 Clock 0 ~ 100 Phase 0 ~ 100 Auto Auto Adjust

Notes:

The details of above Zoom Mode are :

- “ Over Scan “ mode : this is the factory default condition in general, most of target video sizes on the LCD screen mean this mode (5% zoom and cropped). Traditional CVBS input signal requires OverScan mode for general usage.
- “ Normal “ : Displays all available pixels into screen without cropping and zooming.
- “ Zoom “ : Magnifies center of screen by 25%

8.4.5 OSD menu "Setup"

Symbol	Main menu	Sub Menu
	Serial Port	Baud Rate 1200 ~ 57600 Data 5bit ~ 8bit Parity None / Odd / Even Stop 1bit
	User Assign	Keypad > Backlight, Keypad < Volume, F1 Contrast, F2 Flip/Flop, F3 Image Flip, F4 Image Mirror, Mute, Mono, Colour Channel, Red Only, Green Only, Blue Only, Zoom

Notes:

4 kinds of User Hotkey Setting : this is a very convenient way of user choice in order to use the "Remocon (Remote Controller)" How can all users settle this function?

Menu > SETUP > User Assign → then can be selected through the Keypad Up and Keypad Down button on OSD Board
 The F1 ~ F4 are only available with option remote control. The keys are selectable a required function as the HotKey among all the menu among "Backlight, Volume, Contrast, Flip/Flop, Image Flip, Image Mirror, Mute, Mono, Colour Channel, Red Only, Green Only, Blue Only, Zoom"

8.5 Engineering OSD with dimming encoder

SRT/PHT SERIES monitors with option dimming are prepared for OSD-control by encoder-knob or 3-button dimming control. When using option potentiometer, only the power function is available. Please refer to the flow chart below for instructions:

Symbol	Encoder	External Buttons
●	Switch function of encoder (press knob to activate)	Middle button
→	Increase, rotate CW	Right button
←	Decrease, rotate CCW	Left button

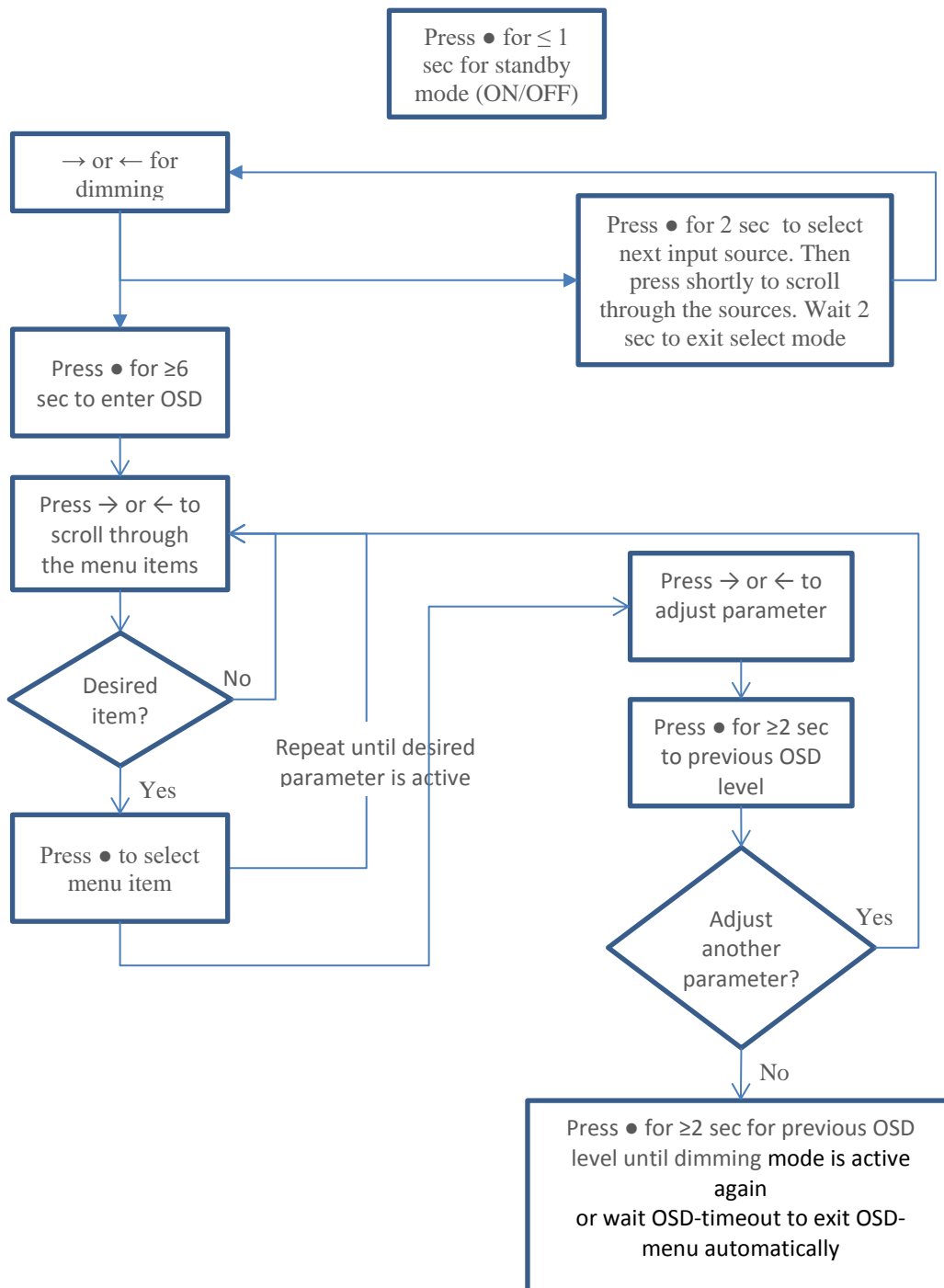

8.6 Projected capacitive touch screen

When using projected capacitive touch screen with USB connection you will NOT need to install any drivers. There is no further calibration needed, it is all factory set.

The surface of the touch screen is pure glass. Scratches will not effect proper operation. The touch screen can be used with bare finger and even with thin gloves. Avoid heavy rain (flow of water) on the surface. This might result in false touches, specially along the edges of the touch screen.

The power of the touch screen runs from the USB-connection to the computer (=external) by default. This means the touch sensor is still enabled while the monitor is powered off. If you prefer the touch screen to be disabled while the monitor is switched to off, just slide the switch gently to the right position with a small screw driver. When using the NCOM option the touch screen power settings can be set in the firmware. Please refer to the NCOM manual for further information.

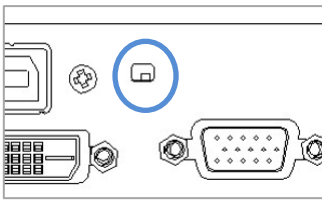

Figuur 8-1 Toggle switch int/ext touch power

Switch position:

Left side: power from USB

Right side: power internal

With RS-232 connection please make sure that older drivers are removed from your PC (OS). Then install the correct drivers. Contact Seatronx for the latest drivers.

8.7 Resistive touch screen

A resistive touch screen can only be applied on the NxxxK and NxxxKE models, not on the full glass models. For this type of touch screen a driver has to be installed. These touch screen drivers can be downloaded from the website. Please make sure you select the correct operating system. The touch screen is already factory-calibrated.

The surface of the resistive touch screen is made of PET material. This material can be scratched easily. The sensor should only be touched by finger, glove or stylus. Do not touch with tools, screw drivers or any other materials that can scratch or even damage the sensor. Scratching the sensor might cause malfunctioning. The touch sensitive PET-material is laminated to a 2mm glass sheet. The glass might break when hitting the glass of pushing too hard.

9 Trouble shooting

9.1 Power

Symptom	Problem	Action
No status LED indication (with internal DC/DC converter)	<ul style="list-style-type: none"> No power to the video board 	<ul style="list-style-type: none"> Check proper pinning of power connections Check proper fitting of the wires in the screw connector Check proper fitting of the power connector in the socket Measure voltage on power connector. Should be 9~34VDC Check right dimensioning of the power cables
No status LED indication (with internal DC/DC converter)	<ul style="list-style-type: none"> No power to the video board 	<ul style="list-style-type: none"> Check proper fitting of the DC-plug in the socket Check the LED on the power adapter Check fitting of connectors on the mains power cord

9.2 Image

Symptom	Problem	Action
<ul style="list-style-type: none"> A message appears on the screen: "No signal" Status-LED lights up red and there is no image on the screen 	<ul style="list-style-type: none"> Video-source cable not connected (securely) Wrong source-mode 	<ul style="list-style-type: none"> Check proper fitting of the video cables Check the video source (PC, monitor etc.) to be powered and connected correctly Is the Video-source set to ON in the "Source Setting" OSD-menu? When using a splitter, only enable the corresponding source, disable all other sources and set 'auto source' to "off". Try connecting monitor directly to the PC
<ul style="list-style-type: none"> Image colors are not shown right 	<ul style="list-style-type: none"> Missing color in the video source Video cable is too long 	<ul style="list-style-type: none"> Check proper fitting of the VGA connector Try different cable Use shorter cable
<ul style="list-style-type: none"> Image is not positioned correctly, not centered or not full screen (zoomed or cropped). 	<ul style="list-style-type: none"> Pixel settings might have been changed Video source has changed Zoom mode is not set correctly Wrong resolution from source VGA settings not adjusted correctly 	<ul style="list-style-type: none"> Did you select the right video-mode on the source (PC)? Push the > button. This is a hot-key for auto adjustment Set the right parameter through the OSD menu-function-zoom mode Check resolution from your pc → Connect all sources and restart the pc. Push the '>' button. This is a hot-key for auto adjustment

Symptom	Problem	Action
<ul style="list-style-type: none"> Black screen 	<ul style="list-style-type: none"> No power No valid input Monitor in standby/sleepmode screen becomes too hot 	<ul style="list-style-type: none"> Check polarity of power wires Check input signal Check color OSD led. Red: → push dimming knob or standby button from OSD Switch off the monitor and wait until temperature is normal. Arrange proper cooling inside the cabinet/desk
<ul style="list-style-type: none"> Black/blinking screen when set to full brightness 	<ul style="list-style-type: none"> Insufficient power from source 	<ul style="list-style-type: none"> Check current rating of the power input source.

9.3 Dimming control

Symptom	Problem	Action
<ul style="list-style-type: none"> External potentiometer/encoder isn't working: 	<ul style="list-style-type: none"> External dimming knob not connected before connecting power to the unit 	<ul style="list-style-type: none"> Disconnect power, connect NCOM-IN (RJ45) plug and connect power again

9.4 Touch screen

Symptom	Problem	Action
<ul style="list-style-type: none"> When you touch the screen no touch is detected 	<ul style="list-style-type: none"> Touch screen cable is not connected (securely) Touch drivers are not installed (resistive touch screen) 	<ul style="list-style-type: none"> Check proper fitting of the touch screen cables Install the drivers from the CD-Rom
<ul style="list-style-type: none"> A false touch is generated along the edge of the glass 	<ul style="list-style-type: none"> There is a flow of water on the surface of the glass 	<ul style="list-style-type: none"> Place the touch screen in a different edge Avoid excessive water to flow over the front surface
<ul style="list-style-type: none"> Touch not working on RS232 	<ul style="list-style-type: none"> No correct drivers installed Touch should be powered INTERNAL. 	<ul style="list-style-type: none"> Make sure all older drivers are removed from your OS, then reboot system and install latest driver For latest drivers contact Seatronx. Set power switch to internal or set correct power settings in NCOM
<ul style="list-style-type: none"> Touch not working i.c.w. black box and USB 	<ul style="list-style-type: none"> Black box is solely working with USB. 	<ul style="list-style-type: none"> Set switch to EXTERNAL (default, via App). Touch screen will be powered by the 5VDC from the USB port of the PC.
<ul style="list-style-type: none"> Touchscreen not accurate 	<ul style="list-style-type: none"> Poor grounding 	<ul style="list-style-type: none"> Check proper GND

Symptom	Problem	Action
<ul style="list-style-type: none"> Resistive touch: Touch not working. 	<ul style="list-style-type: none"> Cc No drivers installed 	<ul style="list-style-type: none"> Cc Install driver for RS232. For latest drivers visit www.eeti.com.tw/drivers.html
<ul style="list-style-type: none"> Bad cursor positioning 	<ul style="list-style-type: none"> Poor calibration 	<ul style="list-style-type: none"> perform a 4-points calibration. Still not accurate: perform a 9- or 25-points
<ul style="list-style-type: none"> Cursor is moving to a corner 	<ul style="list-style-type: none"> scratch/damaged surface 	<ul style="list-style-type: none"> Check for damage monitor is mounted too tight.

10 Specifications

For detailed dimensional drawings for each model, please refer to the related sheets which can be found on our website

10.1 Video

10.1.1 Compatibility and video standards

- State of the art high performance picture quality complying with Broadcasting Monitor and Medical Monitor
- Analog RGB / DVI / HDMI / CVBS
- Full CRT multi-sync monitor compatibility
- Multi-sync capability up to WUXGA resolution @ 60Hz, compatible standard
- DOS, VGA, SVGA, XGA and SXGA / WUXGA VESA timing
- Expand DOS, VGA and SVGA to full screen display
- True color(16.7 M) data processing and display driving
- Single control operated On-Screen-Display (hereafter "OSD") user interface
- Full control of all relevant display and interface parameters via OSD
- Multi language support(5 Language and more(Optional))
- VESA DDC 1/2B compliant
- Compatible with VESA DPMS power saving modes
- Multi-standard color system at CVBS (PAL / NTSC)
- Image Flip / Mirror supportable by AD board
- Serial Control (RS232C) ready

10.1.2 Applicable Graphic Mode

The microprocessor measures the H-sync, V-sync and V-sync/H-sync polarity for RGB inputs, and uses this timing information to control all of the display operation to get the proper image on a screen.

The monitor can detect all VESA standard and MAC Graphic modes shown on the table below and provide more clear and stable image on a screen.

Table 1 RGB Input format

Spec. Mode	Pixel Freq.		Horizontal Timing				Vertical Timing			
			Sync Polar	Freq.	Total	Active	Polar Sync	Freq.	Total	Active
	MHz			KHz	Pixel	Pixel		Hz	Line	Line
640x350@70Hz	25.144	VESA	P	31.430	800	640	N	70.000	449	350
720x400@70Hz	28.287	VESA	N	31.430	900	720	P	70.000	449	400
640x480@60Hz	25.175	MAC	N	31.469	800	640	N	59.940	525	480
640x480@60Hz	25.175	VESA	N	31.469	800	640	N	59.940	525	480
640x480@67Hz	30.240	MAC	N	35.000	864	640	N	66.667	525	480
640x480@72Hz	31.500	VESA	N	37.861	832	640	N	72.809	520	480
640x480@75Hz	31.500	VESA	N	37.500	840	640	N	75.000	500	480
832x624@75Hz	57.284	MAC	N	49.726	1152	832	N	74.551	667	624
800x600@56Hz	36.000	VESA	P	35.156	1024	800	P	56.250	625	600
800x600@60Hz	40.000	VESA	P	37.879	1056	800	P	60.317	628	600
800x600@72Hz	50.000	VESA	P	48.077	1040	800	P	72.188	666	600
800x600@75Hz	49.500	VESA	P	46.875	1056	800	P	75.000	625	600
1024x768@60Hz	65.000	VESA	N	48.363	1344	1024	N	60.005	806	768
1024x768@60Hz	64.000	MAC	N	48.780	1312	1024	N	60.001	813	768
1024x768@70Hz	75.000	VESA	N	56.476	1328	1024	N	70.070	806	768
1024x768@75Hz	80.000	MAC	N	60.241	1328	1024	N	74.927	804	768
1024x768@75Hz	78.750	VESA	P	60.023	1312	1024	P	75.030	800	768
1280x768@60Hz	79,500	VESA	P	47,780	1664	1280	P	59,870	798	768
1280x1024@60Hz	108.000	VESA	P	63.981	1688	1280	P	60.020	1066	1024
1280x1024@75Hz	135.000	VESA	P	79.976	1688	1280	P	75.025	1066	1024
1360X768@60Hz	85.00	VESA	P	47.712	1792	1360	P	60.015	795	768
1600x1200@60Hz	160.875	VESA	N	74.479	2160	1600	P	59.967	1242	1200
1680x1050@60Hz	147.000	VESA	N	65.160	2256	1680	P	59.944	1087	1050
1920x1080@60Hz	172.750	VESA	N	67.061	2576	1920	P	59.983	1118	1080
1920X1200@60Hz	193.125	VESA	N	74.508	1292	1920	P	59,990	1242	1200

10.2 Dimensions K, KE, KG and KGE models

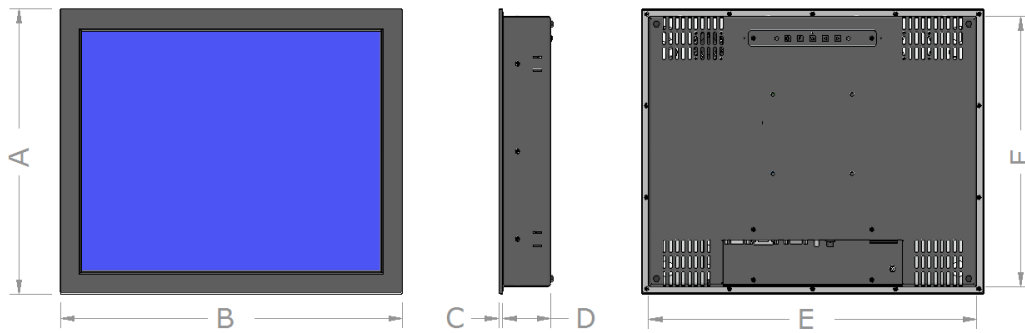

Model	A (K, KG)	A (KE, KGE)	B	C (K, KE)	C (KG, KGE)	D	E	F (K, KG)	F (KE, KGE)
N104	211.4	227.4	262.4	5	5.8	61	244.4	193.4	209.4
N106	195.6	-	288.2	-	5.8	61	270.2	177.6	-
N121	-	257.3	301.8	-	5.8	61	283.6	-	239.1
N121W	228.2	-	320.7	-	5.8	61	302.7	210.2	-
N150	289.1	305.1	363.1	5	5.8	61	345.1	271.1	287.1
N154	265.6	-	388.6	-	5.8	61	370.6	247.6	-
N156	254.5	272.5	403.8	-	5.8	61	385.8	236.5	254.5
N170	325.5	342.0	396.9	5	5.8	61	378.9	307.5	324
N185	288.4	-	466.2	-	5.8	61	448.2	270.4	-
N190	359.2	377.2	432.6	5	5.8	61	414.6	341.2	359.2
N215	-	345.4	538.0	-	5.8	61	520.0	-	327.4
N230	347.2	363.6	569.8	5	5.8	61	551.8	329.2	345.6
N240	-	382.8	598.6	-	5.8	61	580.6	-	364.8
N241	385.2	404.2	587.0	5	5.8	61	569.0	367.2	386.2
N270	-	413.8	656.2	5	5.8	61	638.2	-	395.8
N320	-	479.4	774.2	-	5.8	71	756.2	-	461.4

- =Not available (yet)

Before making a cutout always check the dimensional drawings.

10.3 Dimensions D and DE models

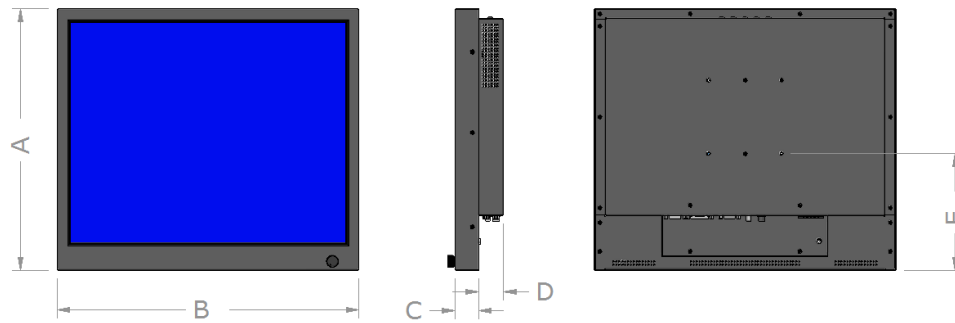

Model	A (D)	A (DE)	B	C (D, DE)	C (DG, DGE)	D	E	VESA
N84	-	182.7	223.0	32	-	34	93.7	75x35
N104	-	207.7	242.4	32	-	34	86.2	75
N121	-	237.4	281.6	32	-	34	100.6	75
N150	-	285.1	343.1	32	-	34	122.3	100
N156	-	252.8	383.8	32	-	34	107.3	100
N170	-	322.0	376.9	32	-	34	140.9	100
N190	-	357.5	412.6	32	-	34	159.6	100
N230	-	343.6	549.8	32	-	34	151.8	100 MIS-E
N240	-	362.8	578.6	32	-	34	161.6	100 MIS-E
N241	-	384.2	567.0	32	-	34	173.3	100 MIS-E
N320	-	459.7	754.2	32	-	34	159.1	VESA MIS-F
N420	-	570.2	977.2	5	-	61	207.5	600x200 M6

- = Not available (yet)

10.4 Dimensions R models

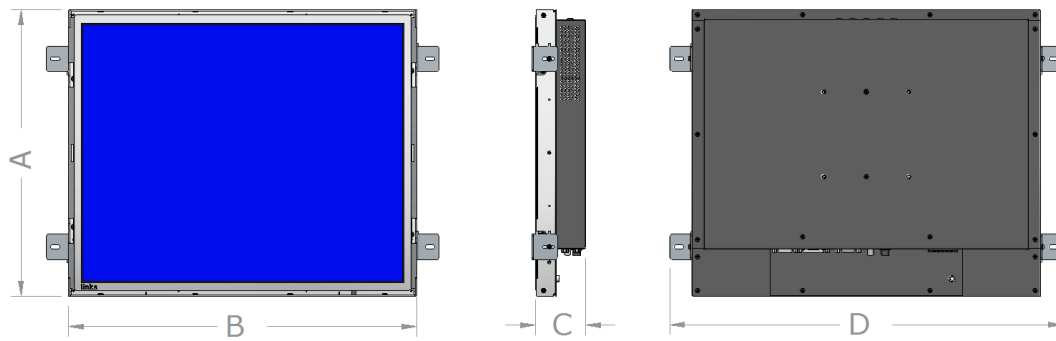

Model	A	B	C*	D
N104	188.8	239.8	59.0	292.8
N106	173	265.6	59.0	318.6
N121	-	-	-	-
N121W	-	-	-	-
N150	266.5	340.5	59.0	393.5
N154	243.0	366.0	59.0	419.0
N156	-	-	-	-
N170	302.9	374.3	59.0	427.3
N185	-	-	-	-
N190	336.6	410.0	59.0	463.0
N215	-	-	-	-
N230	324.6	547.2	59.0	600.2
N240	-	-	-	-
N241	362.6	564.4	59.0	617.4
N320	-	-	-	-
N420	567.1	974.2	86.5	1027.2

- =Not available (yet)

*=dimensions without protective glass or touch screen sensor

10.5 Electrical and environmental

In this manual all basic specifications are summarized. If you need more detailed info please contact us.

Item	Item	Min	Max	Unit
Power	DC Input			
	12VDC -plug	11.2	12.7	VDC
	Ext. DC Power (*1)	9.0	36.0	VDC
Desktop PSU 12VDC	AC Input	100-240V ~ 1,8A, 50-60Hz		
	DC Output	12V ~ 5A		
Desktop PSU 24VDC	AC Input	100-240V ~ 12,5A, 50-60Hz		
	DC Output	24V ~ 6,25A		
IP-rating				
	NxxxK, NxxxKE (Front only)		IP55	
	NxxxKG, NxxxKGE (Front only)		IP65	
	NxxxD, NxxxDE, NxxxDG, NxxxDGE		IP2x	
Storage temperature		-20	60	°C
Operating temperature		-15	55	°C



*1) 9~36VDC input – tested at nominal input voltage: 24.0VDC

10.6 Model related specifications

Parameter	N84	N104	N106	N121	N121W	N150	N154	N156	N170	N185	N190	N215	N230	N240	N241	N270	N320	N420
Active area (mm)	170x128	211x158	231x138	246x148	261x163	304x228	331x207	344.2x193.5	337.9x270.3	409.8x230.4	376.3x301.1	477x268	509.2x286.4	531.4x298.9	518.4x324.0	597.6x336.2	698.4x392.8	930x523
Aspect ratio	4:3	4:3	5:3	4:3	8:5	4:3	16:10 (8:5)	16:9	5:4	16:9	5:4	16:9	16:9	16:9	16:10	16:9	16:9	16:9
Resolution (pixels)	800x600	1024x768	1280x768	800x600	1280x800	1024x768	1280x800	1366x768	1280x1024	1366x768	1280x1024	1920x1080	1920x1080	1920x1080	1920x1200	1920x1080	1920x1080	1920x1080
Vector Video Standard	SVGA	XGA	WXGA	SVGA	WXGA	XGA	WXGA	WXGA	SXGA	WXGA	SXGA	HD1080	HD 1080	HD 1080	WUXGA	HD 1080	HD 1080	HD 1080
Pixel pitch (mm)	0.213	0.264	0.180	0.307	0.204	0.297	0.259	0.256	0.264	0.300	0.294	0.248	0.265	0.277	0.270	0.311	0.363	0.484
Viewing angle LR/UD (° from normal)*4	160/140	178/178	170/170	178/178	178/178	160/140	160/140	170/160	178/178	170/160	178/178	178/178	178/178	178/178	178/178	178/178	178/178	178/178
Max colors	16.2M	16.7M	16.7M	16.2M	16.2M	16.2M	16.2M	16.7M	16.7M	16.7M	16.7M	16.7M	16.7M	16.7M	16.7M	16.7M	16.7M	1073
Contrast ratio	600	1200	1000	1500	1000	700	760	500	1000	1000	1500	5000	1000	3000	1000	3000	3000	4000
Native Brightness (Cd)	450	450	1000	500	400/500	400	400	300	350	300	330	300	300	300	300	350	350	500
Max. power (W) *3	Tbd	17	18	15	Tbd	15	tbd	Tbd	23	tbd	24	Tbd	tbd	tbd	40	tbd	tbd	95
Storage temperature	-30/85	-20/70	-30/60	-30/85	-20/80	-30/85	-30/80	-20/60	-30/85	-20/60	-20/65	-20/60	-20/65	-20/60	-20/65	-20/60	-20/60	-20/65
Operating temperature limits*2	-30/85	-20/65	-30/80	-30/85	-10/70	-30/85	-20/70	0/60	-30/85	0/60	-10/65	0/60	0/50	0/50	0/50	0/50	0/50	0/50
Weight *1	/	/	2.96	/	/	/	4.82	/	6.42	/	/	/	7.84	/	/	/	tbd	30.7

*1 NxxxK(GE)/NxxxD(GE)

*2 If a sunlight readable configuration has been selected, make sure the temperature is regulated by cooling from the back side to meet temperature specifications.

*3 Maximum power without options.

*4 Viewing angle is an theoretical value measured with standard colors and contrast. In real life the monitor should be installed with angle: $120 < \alpha < 90$. This means that viewing from bottom side should be avoided. For viewing convenience install the monitor below eye-level (max height).

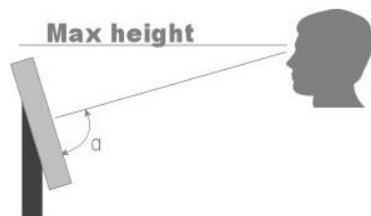

10.7 Pin assignments

DVI Input (DVI D-Type)

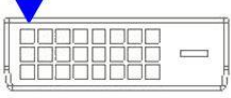

(L-R row-wise)

Pin	Function	Pin	Function	Pin	Function	Pin	Function	Pin	Function
1	TX2-	6	DDC CLK	11	TX 1/3 Shield	16	H/P Detect	21	NC
2	TX2+	7	DDC data	12	NC	17	TX0 -	22	TXClk Shield
3	Data2/4 shield	8	NC	13	NC	18	TX0 +	23	TXCLK+
4	NC	9	TX1-	14	DC +5V	19	TX0/5 Shield	24	TXCLK-
5	NC	10	TX1+	15	Ground	20	NC		

HDMI Input



(U/D zig-zag)

Pin	Function	Pin	Function	Pin	Function	Pin	Function	Pin	Function
1	Data2 +	5	Data1 Shield	9	Data0 -	13	CEC	17	DDC/CEC GND
2	Data2 Shield	6	Data1 -	10	CLK +	14	NC	18	DC +5V
3	Data2 -	7	Data0 +	11	CLK Shield	15	DDC SCL	19	HP Detect
4	Data1 +	8	Data0 Shield	12	CLK -	16	DDC SDA		

VGA Input (D-SUB 15Pin)

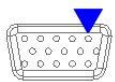

(R-L row-wise)

Pin	Function	Pin	Function	Pin	Function	Pin	Function	Pin	Function
1	Red	4	NC	7	GND	10	GND	13	HSYNC
2	Green	5	Check Signal	8	GND	11	NC	14	VSYNC
3	Blue	6	GND	9	NC	12	DDC_SDA	15	DDC_SCL

12 VDC input plug



Pin	Function	Pin	Function	Pin	Function	Pin	Function	Pin	Function
1	+12VDC	2	Detect	3	GND				



This option is not part of certification

9~36 VDC input connector, max wire 2,5mm²

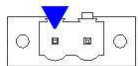

Pin	Function	Pin	Function	Pin	Function	Pin	Function	Pin	Function
1	+9~36VDC (nom. 24VDC)	2	GND						

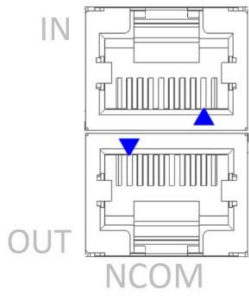

NCOM IN (RJ45)

Pin	Function	Pin	Function	Pin	Function	Pin	Function	Pin	Function
1	12V (LIN power)	2	-	3	LIN-bus	4	RS485 D+	5	RS485 D-
6	-	8	GND						

NCOM OUT (RJ45)

Pin	Function	Pin	Function	Pin	Function	Pin	Function	Pin	Function
1	-	2	-	3	-	4	RS485 D+	5	RS485 D-
6	-	8	GND						



This option is not part of certification

RS232 touch (DB9-female)

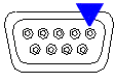

(R-L row-wise)

Pin	Function	Pin	Function	Pin	Function	Pin	Function	Pin	Function
1	-	3	TXD	5	GND/drain	7	-	9	-
2	RXD	4	-	6	-	8	-		

11 Pixel policy (ISO 13406-2 Scan Guidelines)

TFT monitors are precise units made up of a set number of pixels. Unfortunately this can be seen as a weakness. Pixels are made up the three sub-pixels being red, green and blue each consisting of their own transistors that controls whether or not it lights up. Due to the way in which panels are made, defects can unfortunately appear resulting in 'dead pixels' which cannot be repaired neither can it be predicted when the failure may occur.

The monitor can be working at 100% however can consist of pixels or sub-pixels which are either:

- a) Permanently dark or light which is not always evident OR
- b) A constant flash which is more noticeable.

Fortunately there is an ISO 13406-2 (Class II) standard which covers the maximum number pixels on any given panel.

There are 4 classes.

Class I monitors are guaranteed products which do not have any defects at all .

Class II specification consists of the following faults permissible: 2 x Type 1, 2 x Type 2, 5 x Type 3 and 2 x Type 4.

Class III and IV are not being explained, for they have more defect pixels and are used in office environments.

The pixel faults are defined in the following way:

Type 1) constant bright pixel

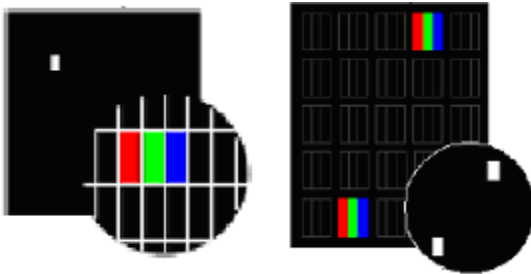

Type 2) constant dark pixel

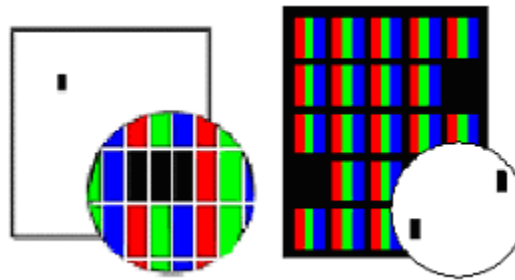

Type 3) defect pixel, either constantly bright (red, green, blue or constantly dark)

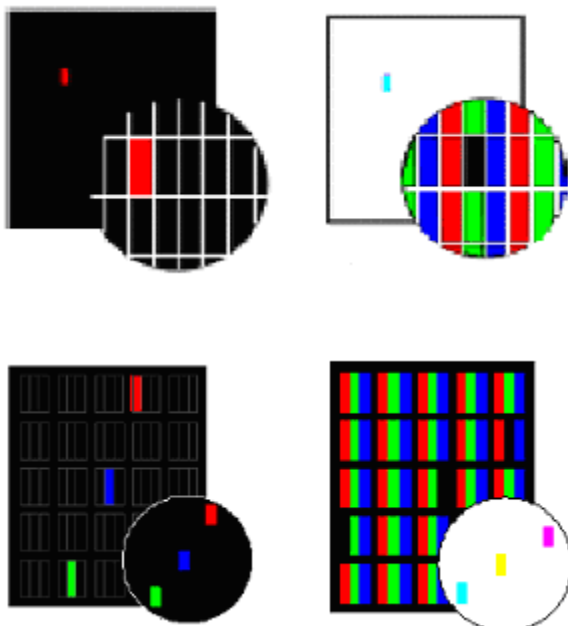

Type 4) fault cluster, the number of defective pixels in a 5 x 5 pixel square.

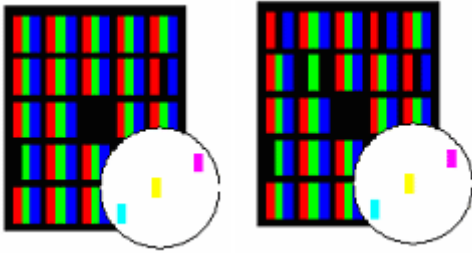

Class I monitors are guaranteed products which do not have any defects at all .

Class II specification consists of the following faults permissible: 2 x Type 1, 2 x Type 2, 5 x Type 3 and 2 x Type 4. Seatronx delivers TFT Monitors in accordance to ISO 13406-2 Class II. Special arrangements can be made.

The number of permissible pixel faults can be calculated with the following function:

(number of errors = number of pixels of the physical resolution x number of errors in the pixel fault category / 1.000.000) with rounding up upward

(there it no half errors gives).

The following table defines the maximum permissible number of pixel faults for the respective resolution types validly for the pixel error class II.

Panel type	Physical Resolution	Number of pixel	Maximally permissible number of errors for the pixel error classII in accordance with ISO 13406-2				
			Type 1	Type 2	Type 3	Cluster fault (all types)	Cluster fault Typ 1 & Typ2
15" XGA	1024 x 768	768 432	2	2	4	2	2
17"-19"	SXGA 1280 x 1024	1 310 720	3	3	7	3	3
20.1"	UXGA 1600 x 1200	1 920 000	4	4	10	4	4

12 Sticking image

Image-sticking on LCD monitors

LCD technology has always been known to suffer from certain image retention – Image Sticking, as it has been named. This is caused by ions polluting the material Liquid Crystal Displays are made of, and thus will occur on all LCD's. TFT is the name for the most common used technology in LCD's.

Image Sticking is a slow build up of energy (ions) in pixels that are statically turned on in a LCD. This energy will eventually keep the pixel slightly on, and so cause Image Sticking on the display. Image Sticking and the special forms of it "Ghost Image" and "Boundary Image Retention" is a reversible process, but will in rare cases, where an image has been on a LCD long enough to physically alter the crystals inside the LCD, be permanent.

ISIC has been one of the forerunners in attempts to reduce Image Sticking through active and passive measures. Research has shown that keeping the energy-build up from happening is not possible. Removing all DC components within the driving signal has removed "Ghost Images", but any bright color displayed on a dark background will still cause "Boundary Image Retention".

Caused by ions, being moved around by voltage-levels, Image Sticking will only disappear by switching the LCD off. A simple rule says that Image Sticking takes approximately as long time to disappear as it takes to be created. Tests at ISIC have shown that Image Sticking is accelerated by temperature (greater moving activity in the ions). Freezing the LCD may reduce Image Sticking, as may impose an alternating electrical field across the display. Both these ways of removing Sticking Image have been deemed unusable in working installations.

The only action against Image Sticking on LCD's is to follow the guidelines below.

- 1) Avoid displaying static images for longer periods (weeks). Use screen savers or auto LCD switch off procedures in times where the system is not active.
- 2) Run LCD's at maximum 80% brightness and contrast – the reduction will only be seen as an 8% reduction in light-level to the human eye.
- 3) Create “panning” images to prevent static lines and text building up Boundary Image Retention.
- 4) Use soft colors – light grey – dark grey – light yellow - a.s.o.
- 5) Check displays for Boundary Image Retention using a 50% grey, and imply on of guidelines 1 to 4 when Boundary Image Retention is starting to form.

13 Maintenance

There are no user serviceable parts inside the monitor. When the monitor is used in its intended environment there is not much maintenance needed. Please follow these directions:

- Turn off the product and disconnect from the power source before cleaning or maintenance.
- To reduce the risk of electric shock, follow all safety notices and never open the touch monitor case
- Avoid dust and water to enter the monitor and never open the monitor for cleaning. This might damage the components inside.
- Clean the chassis and glass with a soft, slightly moistened cloth. Use glass cleaner, alcohol or petroleum ether. Do not use any abrasive or volatile cleaners.
- Always thoroughly dry off any moisture on the monitor and glass before storing.
- Check all mounting screws if these are still sufficient secured
- Never use compressed air to clean the monitor.

14 Warranty

14.1 Coverage of the Warranty

Seatronx warrants any Seatronx monitor first sold to an enduser to be free from defects in components and workmanship under normal use for the duration of the warranty period which is two (2) years (Warranty Period).

The warranty period commences on the date of purchase. Your original purchase invoice (sales receipt), showing the date of purchase, model number and serial number of the monitor, is your proof of the date of purchase.

This Warranty represents a Carry-In warranty to Seatronx or any representative in the country where the monitor has been purchased. The defective monitor should be returned to the original Point of sales (POS)/reseller for repair.

This Warranty covers the costs of service parts and labour required to restore your monitor to full working order. Seatronx will, at its option, repair or replace any defective monitors or parts thereof covered by this Warranty with new or factory-refurbished parts or monitors that are equal to new products in performance. A monitor or part that is repaired or replaced under this Warranty shall be covered for the remainder of the original warranty period applying to the monitor or part. For batteries the warranty period is limited to one (1) year due to the nature of item. This Warranty does not affect your statutory rights.

14.2 Warranty Exclusions and Disclaimer

The Warranty with respect to your monitor is subject to the following exclusions and limitations:

a) Exclusions

This Warranty does not extend to:

1. any monitor not manufactured by or for Seatronx, or sold to an end-user in a country not covered under this Warranty.
2. any monitor that has been damaged or rendered defective (a) as a result of use of the monitor other than for its normal intended use, failure to use the monitor in accordance with the User's Manual that accompanies the monitor, or other misuse, abuse or negligence to the monitor;
 - (b) by the use of parts not manufactured or sold by Seatronx;
 - (c) by modification of the monitor;
 - (d) as a result of service by anyone other than Seatronx;
 - (e) by improper transportation or packing when returning the monitor to the Point of Sales (POS)/reseller; or
 - (f) by improper installation of third party products (e.g. objectives).
3. any monitor or parts thereof from which labels or serial numbers have been modified or made illegible.
4. loss of any, or damage to data. You are responsible for saving (backing up) any data or removable storage media. Seatronx may opt to replace the monitor submitted for warranty services with a manufactured monitor of equal quality, and, thus, any data stored by you on your original monitor may become permanently inaccessible to you.
5. fair wear and tear of consumable parts, i.e., parts that require periodic replacement during the normal course of the monitors usage, including without limitations, batteries, AC Adaptaters, AC/USB/AV cable, remote control or appearance parts.
6. cosmetic damages such as scratches and dents, scratched, faded or discoloured covers and plastics. Seatronx is not liable for any transport/delivery/ insurance costs, import duties, taxes, licensing fees and any charges from telephone/fax communication as consequence of the failure of the monitor.
7. Seatronx supplies no warranty, either expressed or implied, for any bundled software, its quality, performance, merchantability, or fitness for a particular purpose. Nor does Seatronx warrant that the functions contained in the software will meet your requirements or that the operation of the software will be uninterrupted or error-free. As a result, unless otherwise stated in writing, the software is sold "as is".

b) Disclaimer of Warranty

Except for the express warranty provided and to the extent permitted by applicable law, Seatronx, its Authorized Resellers or Authorized Service Providers do not issue any warranty or guarantee for your monitor. Seatronx expressly excludes any other liability, whether express or implied, to the fullest extent allowed by the law. In particular, but without limit to the generality of the exclusion, any implied terms as to merchantability, satisfactory quality, fitness for a particular purpose and/or non-infringement of third party rights are excluded whether in contract or tort. Any implied warranties that may be imposed by law are limited in duration to the term of the express warranty given by Seatronx to the extent permitted by applicable law. To the maximum extent permitted by applicable law, in no event shall Seatronx or its supplier be liable for (1) damage to, or loss or

corruption of data or removable storage media, or (2) any damages whatsoever (including direct or indirect damages, loss of business profits, lost savings or other special, incidental, exemplary or consequential damages whether for breach of warranty, contract, strict liability, tort or otherwise) arising out of or resulting from the use of or inability to use the products and/or the enclosed written materials, even if Seatronx, its supplier, an authorized Seatronx representative, service provider or dealer have been advised of the possibility of such damages or of any claim by any third party. Any liability of Seatronx or its supplier which is not excluded shall be limited to the purchase price of the monitor.

14.3 Obtaining Warranty Service

Your Seatronx Warranty includes a Carry-In warranty service. The warranty service will be subject to the following terms and conditions:

1. Consult the User's Manual accompanying your monitor for important tips on how to operate and troubleshoot your monitor;
- Note down monitor name, model number, serial number and a description of the problem (e.g. error messages that appear on the screen);
2. Under the terms of Carry-in warranty service, you will be required to deliver your Seatronx monitor including battery, power cord and AC adapter to the Point of sales (POS)/reseller. For further information on the Seatronx range of options and accessories contact your reseller or visit the Seatronx web site www.seatronx.com

NOTES

NOTES